

TOTOKU

CABLE & ASSEMBLY for High-speed digital signal transmission and Microwave signal transmission

Coaxial Cable & Assembly for microwave

High performance Coaxial Cable & Assembly

Wavemolle RUOTA



Microwave Coaxial Cable Assembly

Multi Port Coaxial Connector & Cable Assembly with very narrow pitch TMNP series

High Performance Coaxial Cable

High Performance Coaxial Cable RUOTA Assembly

Wavemolle

Coaxial Cable & Assembly for Microwave

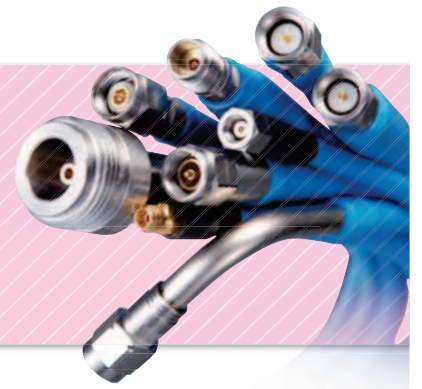

Features

- For 145GHz application
- Very high flexibility
- Very low attenuation and low reflection characteristic
- Corresponds to the specified assembly length (in mm)
- Phase matching technology
- Prepared conversion type assembly for connectors (ex. 2.4M to 2.92F)
- Angle type connector, armor type cable

Applications

- Millimeter wave radar-related high frequency devices
- Beyond 5G (6G) device related high frequency device development
- Internal / external wiring for high-frequency devices
- High-frequency measuring instrument
- Telecommunications equipment (including optical)

Cable design

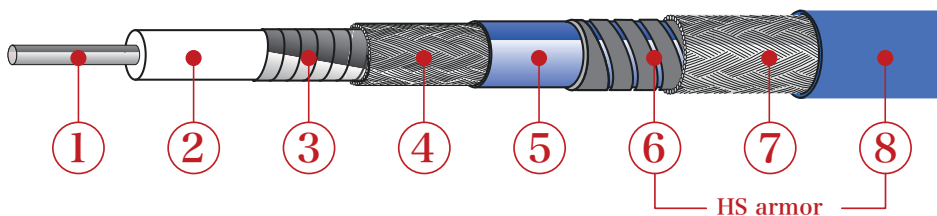

① Inner conductor
Solid silver plated copper wire

② Insulator
Porous PTFE or PTFE

③ 1st Outer conductor
Metal tape

④ 2nd Outer conductor
Metal braid

⑤ Inner Jacket
FEP

⑥ 1st armor
Stainless steel coil

⑦ 2nd armor
Stainless steel braided wire

⑧ Outer Jacket
Poly-olefin or PVC

Electrical cable data

- Characteristic impedance $\lt;50\Omega>$
- Capacitance $\lt;85\text{pF/m}>$
- Time delay $\lt;4.3\text{n/s}>$
- Transmission rate $\lt;78\%>$
- Temperature range $\lt;-55^{\circ}\text{C}\sim 125^{\circ}\text{C}>$(HS armor supports from -30°C to 105°C .)>

Wavemolle

Coaxial Cable & Assembly for Microwave

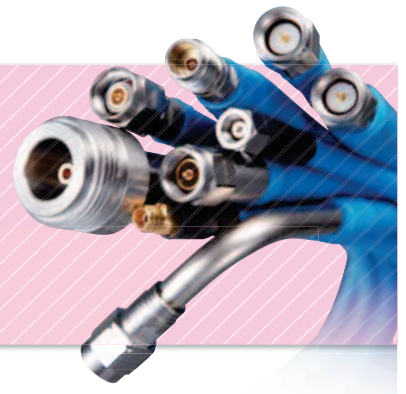

Structure and Electrical and Thermal performance list of Coaxial Cable

Cable P/N	(Inner) Sheath		Min. bending radius(static) [mm]	Moding frequency [GHz]	Temp. range [°C]	"H" Armor Outer sheath			"HS" Armor Outer sheath			"SJ" Soft Outer sheath		
	Material	O.D. [mm]				Material	O.D. [mm]	Temp. range [°C]	Material	O.D. [mm]	Temp. range [°C]	Material	O.D. [mm]	Temp. range [°C]
TCF107	FEP (blue)	—	10	150	—	—	—	—	Poly olefin	4.3	-65 ~ +125	—	—	—
TCF119	FEP (blue)	—	10	134	—	—	—	—	Poly olefin	4.3	-65 ~ +125	—	—	—
TCF128(HS)	FEP (blue)	1.6	10	110	-65 ~ +125	—	—	—	Poly olefin	4.3	-65 ~ +125	—	—	—
TCF219(H,HS)	FEP (blue)	2.7	15	75	-65 ~ +125	Poly olefin	7.6	-30 ~ +85	PVC	7.1	-30 ~ +105	—	—	—
TCF280(H,HS)	FEP (blue)	3.3	20	52	-65 ~ +125	Poly olefin	7.6	-30 ~ +85	PVC	7.1	-30 ~ +105	—	—	—
TCF358(H,HS,SJ)	FEP (blue)	4.1	20	41	-65 ~ +125	Poly olefin	8.6	-30 ~ +85	PVC	7.7	-30 ~ +105	Poly-olefin	5.2	-55 ~ +105
TCF500(H,HS,SJ)	FEP (blue)	5.6	25	27	-65 ~ +125	Poly olefin	10.2	-30 ~ +85	PVC	9.2	-30 ~ +105	Poly-olefin	6.8	-55 ~ +105

Cable lineup, suitable connectors, etc.

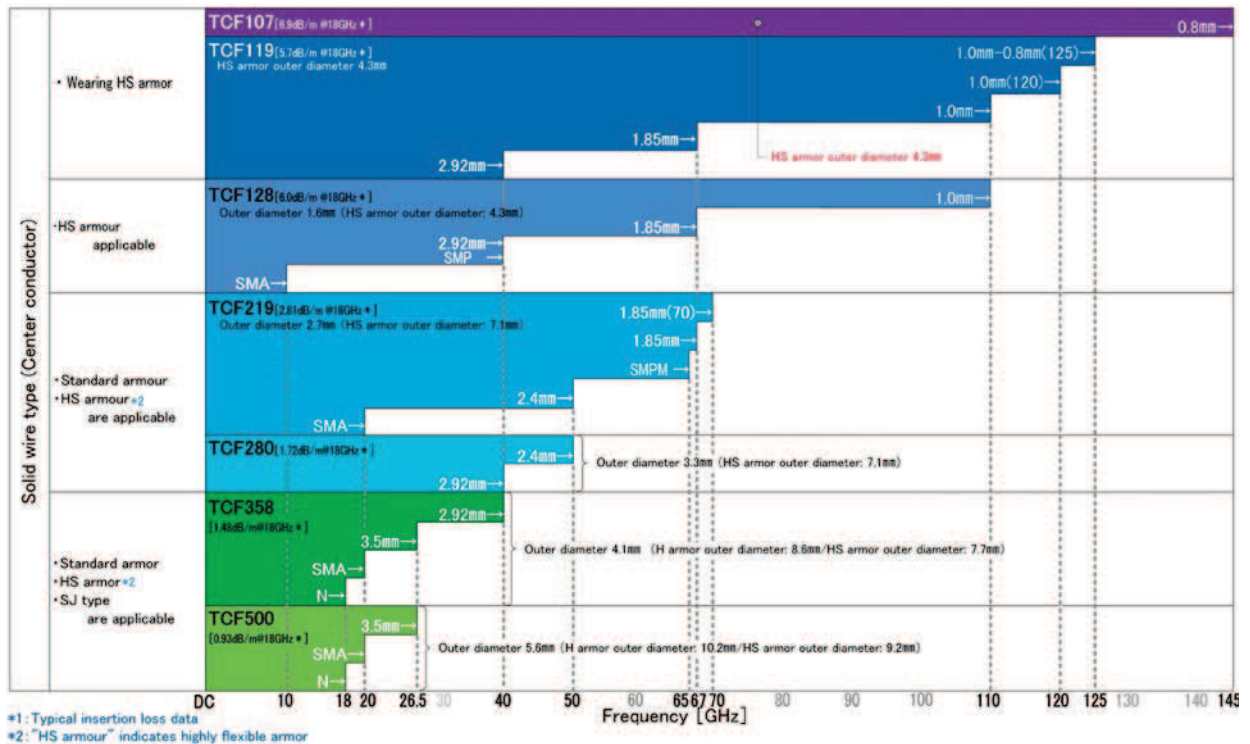



Wavemolle

Connector & Cable combination list

Inner conductor:			Cable type																	
			Normal					soft jacket		Standard armor				Soft armor						
			Solid					Solid		Solid				Solid						
Connector	P/N Symbol	500	358	280	219	128	500SJ	358SJ	500H	358H	280H	219H	500HS	358HS	280HS	219HS	128HS	119	107	
Connector type	18GHz	N-P	D	○	○			△	○	○	○			○	○					
		N-J	E	○	○			△	○	○	○			○	○					
		N-LP	DL	○	○			△	○	○	○			○	○					
		N-LJ	EL	○	○			△	○	○	○			○	○					
	20GHz	SMA-P	A	○	○		○	△	○	○	○		○	○	○		○			
		SMA-J	B	○	○			△	○	○	○			○	○					
		3.5-P	F	○	○			△	○	○	○			○	○					
		3.5-J	G	○	○			△	○	○	○			○	○					
	26.5GHz	3.5-LP	FL		○				○	○	○			○	○					
		3.5-LJ	GL		○				○	○	○			○	○					
		2.92-P	K		○	○	○	○	○	○	○			○	○	○	○	○	○	○
		2.92-J	M		○	○	○	○	○	○	○			○	○	○	○	○	○	○
	40GHz	2.92-LP	KL		○	○	○		○	○	○			○	○	○				
		2.92-LJ	ML		○	○	○		○	○	○			○	○	○				
		SMP-J	SMP															○		
		2.4-P	Q			○	○					○	○			○	○			
	50GHz	2.4-J	R			○	○					○	○			○	○			
		2.4-LP	QL			○	○					○	○			○	○			
		2.4-LJ	RL			○	○					○	○			○	○			
		SMPM-J	SMPM				○												○	
66GHz	1.85-P	T				○	○					○				○	○	○	○	
	1.85-J	U				○	○					○				○	○	○	○	
	1.85-LP	TL				○	○					○				○	○	○	○	
	1.85-LJ	UL				○	○					○				○	○	○	○	
70GHz	1.85-P	※1 T70G				○	○					○				○	○	○	○	
	1.85-J	※1 U70G				○	○					○				○	○	○	○	
	1.85-LP	※1 TL70G				○	○					○				○	○	○	○	
	1.85-LJ	※1 UL70G				○	○					○				○	○	○	○	
110GHz	1.0-P	X															○	○	○	
	1.0-J	Y															○	○	○	
	1.0-LP	XL															○	○	○	
	1.0-LJ	YL															○	○	○	
120GHz	1.0-P	※2 X120G																○	○	
	1.0-J	※2 Y120G																○	○	
	1.0-LP	※2 XL120G																○	○	
	1.0-LJ	※2 YL120G																○	○	
125GHz	0.8-P	※3 ZP																△		
	1.0-J	※3 1.0J																△		
145GHz	0.8-P	ZP																	○	
	0.8-J	ZJ																	○	
Assembly maximum length (m)		50	21	16	9	0.7	3	3	50	21	16	9	10	10	10	9	0.7	0.7	0.3	
Standard maximum length (m)		20	21	5	2	0.3	3	3	20	21	5	2	10	10	5	2	0.3	0.3	0.3	

When you need an assembly of length more than cable standard maximum length, please inquire to our sales department at each time.

△ is in development, please inquire to our sales department.

※1, 70G, ※2, 120G: Please confirm an item of "model number" of following page.

※3 See page 7 for the TCF119ZP1.0J assembly.

Wavemolle

Coaxial Cable & Assembly for Microwave

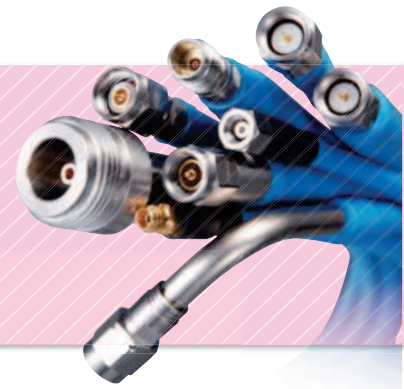

Electrical cable data (typical)

Return loss data(typical)

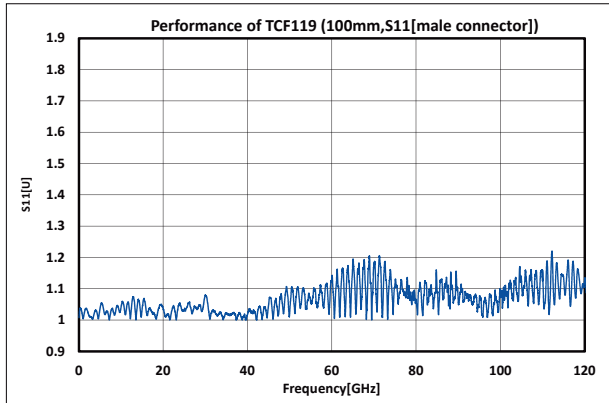

Insertion loss data(typical)

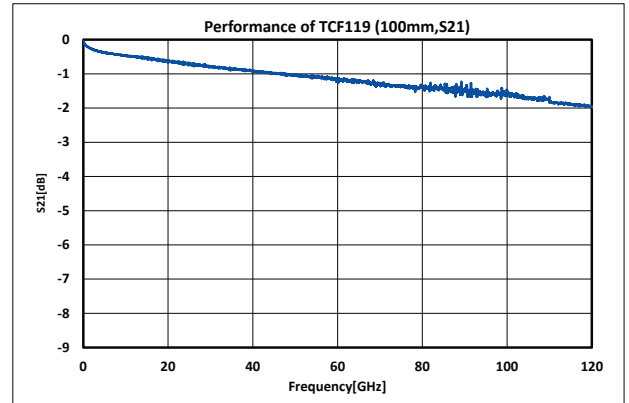

Note) Values within the performance charts are typical values, not guaranteed values.

Phase matching

Relative phase matching (standard: ± 1 ps)
Phase matching in two or more cables in possible.
Please contact us for more information.

Absolute phase matching
We can adjust it to designated electric length.
Please contact us for more information.

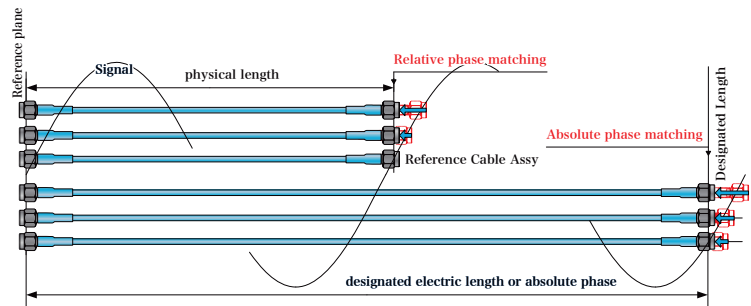

Example

TCF119XX300PM Skew Chart

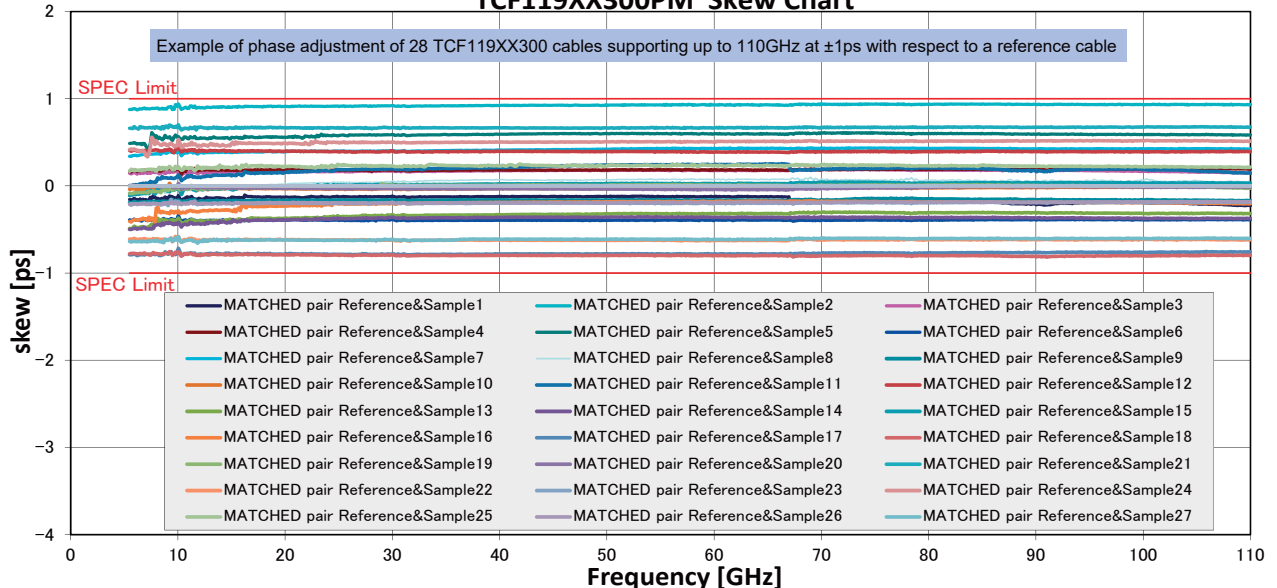



Wavemolle

Dimensions for angle-type connector

TCF119L Assy

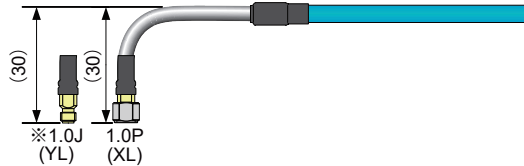

TCF219L Assy

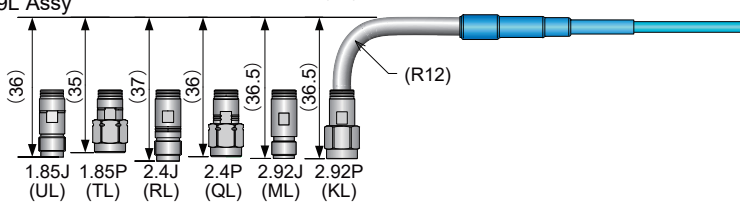

TCF280L Assy

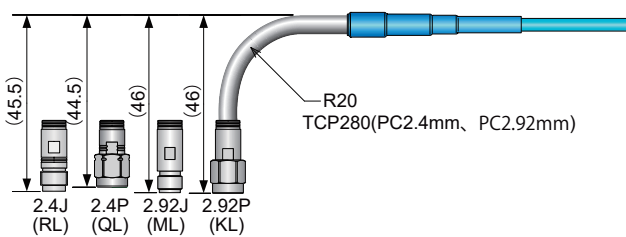

TCF358L Assy

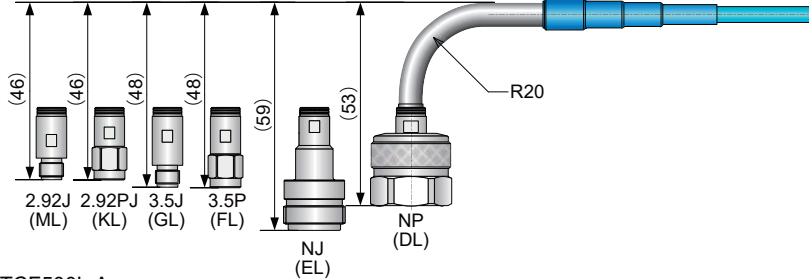

TCF500L Assy

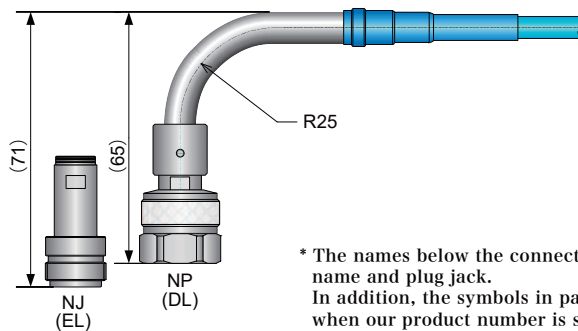

* The names below the connector diagram indicate the connector name and plug jack. In addition, the symbols in parentheses indicate the symbol when our product number is specified.

About angle of connector part

Angles other than right angles (90°) are also available

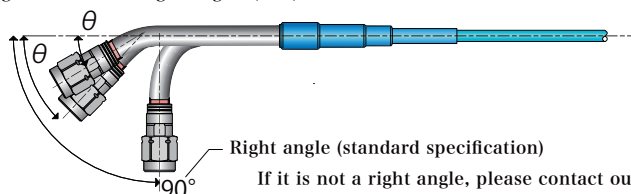

If it is not a right angle, please contact our sales department.



Wavemolle

Model number

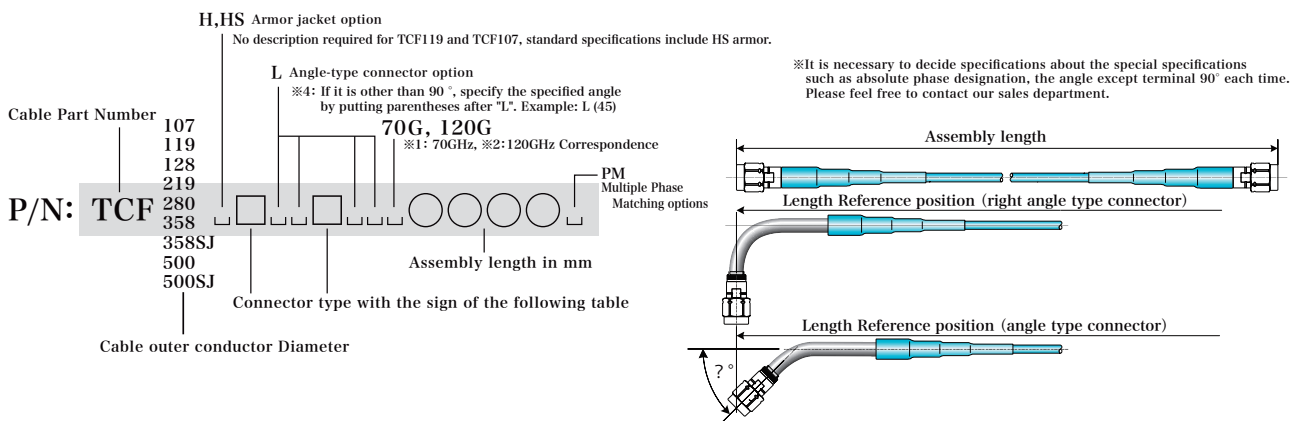

Connector type with the sign table

A	B	D	E	F	G
SMA - Plug	SMA - Jack	N - Plug	N - Jack	3.5mm - Plug	3.5mm - Jack
K	M	Q	R	T	U
2.92mm - Plug	2.92mm - Jack	2.4mm - Plug	2.4mm - Jack	1.85mm - Plug	1.85mm - Jack
T70G ※1	U70G ※1	X	Y	X120G ※2	Y120G ※2
1.85mm - Plug	1.85mm - Jack	1.0mm - Plug	1.0mm - Jack	1.0mm - Plug	1.0mm - Jack
1.0J	ZP	ZJ			
1.0mm - Jack	0.8mm - Plug	0.8mm - Jack			

※2.92mm connector" is also called "K connector". "1.85mm connector" is also called "V connector".

Plug, Jack, connector type conversion Assy

We prepare plug and jack coaxial connectors appropriate to the frequency band that our microwave coaxial cable covers mainly.

In addition, we prepare several types of connectors for same cable. Therefore, production of cable assembly which we connected different types of connectors to at cable both ends is possible.

Combination of armour protection of cable part is possible, too. Please look a connector cable combination of page4 list about combination.

Example	TCF358KM1000	2.92mm Plug - 2.92mm Jack total length 1000mm assembly
	TCF280QK1000	2.4mm Plug - 2.92mm Plug total length 1000mm assembly
	TCF219TM1000	1.85mm Plug - 2.92mm Jack total length 1000mm assembly
	TCF219HSTM1000	1.85mm Plug - 2.92mm Jack, Cable part soft armour protection total length 1000mm assembly

※1,2 Please refer to the following for the part numbers of 70GHz and 120GHz compatible products.

Example	TCF219TU70G1000	1.85mm Plug-1.85mm Jack total length 1000mm 70GHz correspondence assembly
	TCF219HSTU70G1000	1.85mm Plug-1.85mm Jack protected cable part in soft Armour total length1000mm 70GHz correspondence assembly
	TCF119XY120G100	1.00mm Plug-1.00mm Jack total length 100mm 120GHz correspondence assembly

※3, Please refer to the following for part numbers of products that 125GHz correspondence TCF119 (0.8mm plug-1.0mm jack) cable assembly

Example	TCF119ZP1.0J130	0.8mm Plug-1.0mm Jack total length 130mm assembly
	This cable assembly is a special product made for probe head with 0.8mm connector and measurement system using 1.0mm connector. Please feel free to contact our sales staff for details.	

※4, Please refer to the following for part numbers of products that support angle type connectors.

Example	TCF358KLML1000	2.92mm Right Angle Plug-2.92mm Right Angle Jack total length 1000mm assembly
	TCF119XL(45)Y150	1.00mm Angle plug with an about 45°-1.00mm Jack total length 150mm assembly

Best solution for semiconductor evaluation circuit

8-port or 16-port coaxial cable connector assembly is an assembly with very small pitch. This assembly is capable of high-speed transmission throughout a range 67GHz. Through this Connector, TOTOKU contributes to increased high efficiency for the evaluation boards and development of IC chip suppliers.

Photograph



Connector for PCB

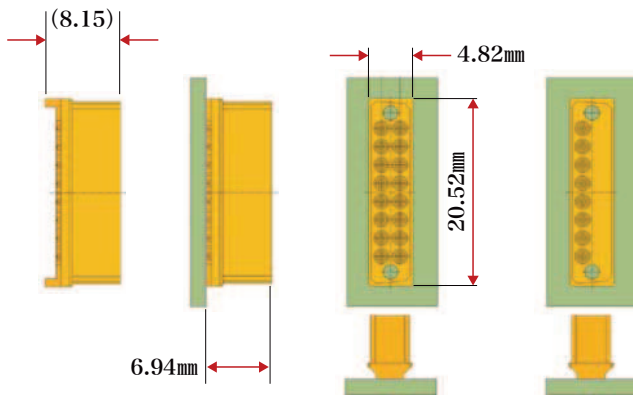

Required space

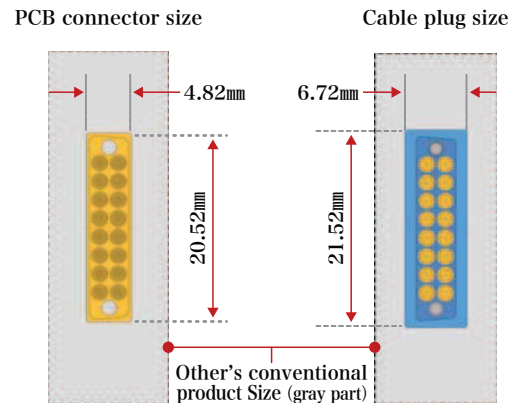

Assembly

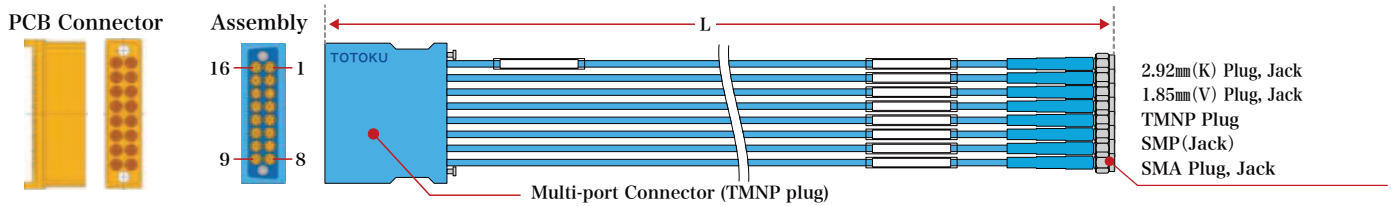

Electric characteristic (typical)

L=9inch 229mm Assy The graph is measurement result of 16 Assy overlay.

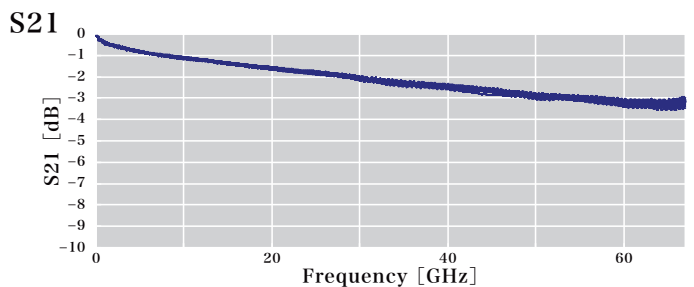
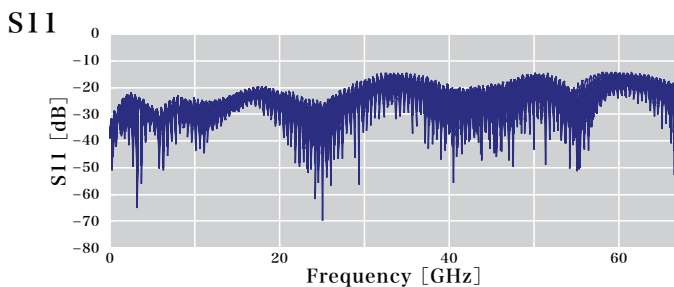

Note) Values within the performance charts are typical values, not guaranteed values.

vemolle

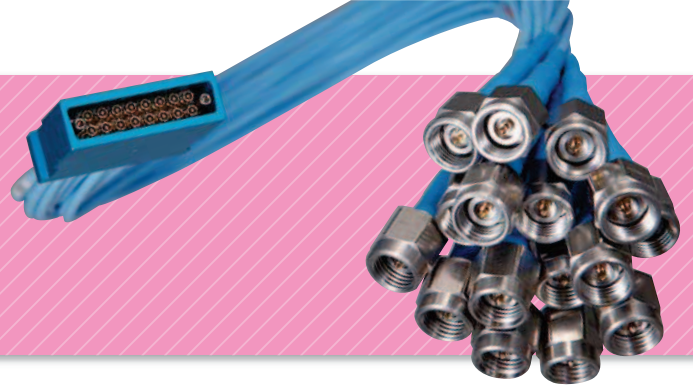

Characteristic example of the multi-port coaxial system

- Cable assy specifications

TCF128TMNP2/V-229
L=9inch(229mm) 1.85mm Plug Assy

- Measurement Board specification

Multi-port PCB connector+ROGERS RO3003*1
+1.85mm board connector

*1 ROGER RO3003($\epsilon_r=3.0, \tan\delta=0.0013, t=0.127\text{mm}$) substrate
bonding the FR-4($t=1.6\text{mm}$) as a reinforcing purposes

Photograph

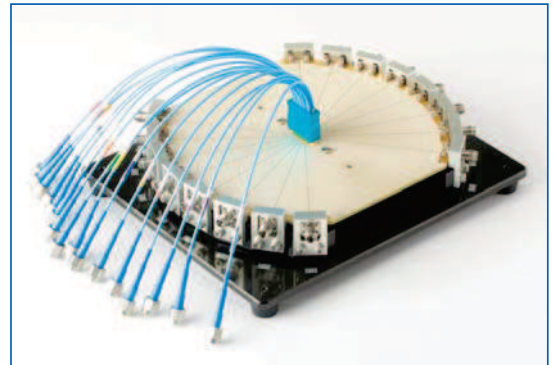

- Insertion loss, VSWR measurement(Typical)

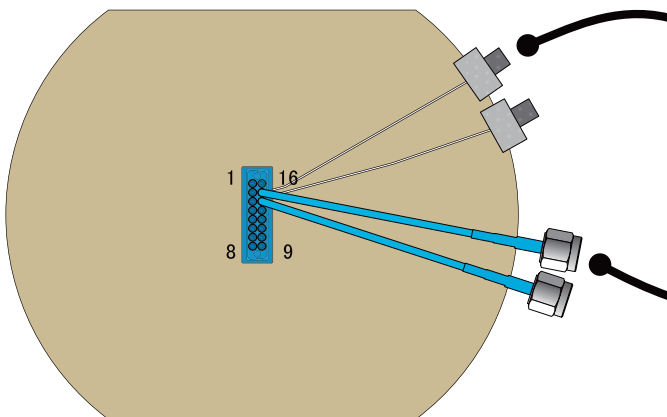

- Crosstalk measurement(Typical)

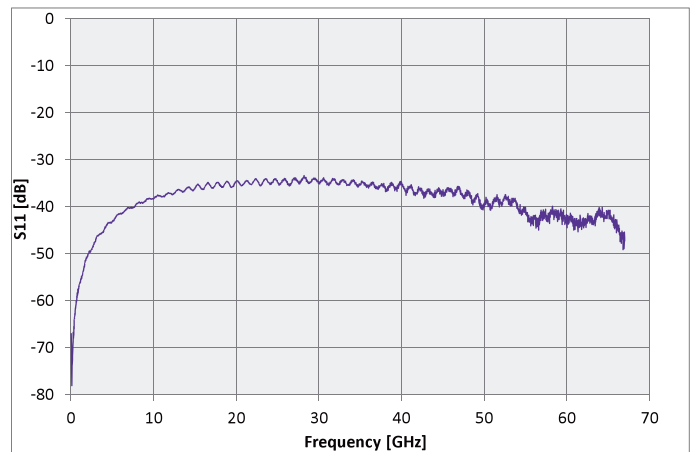
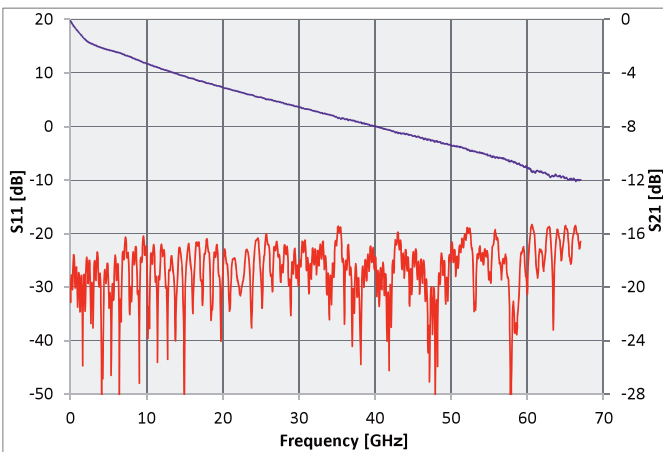
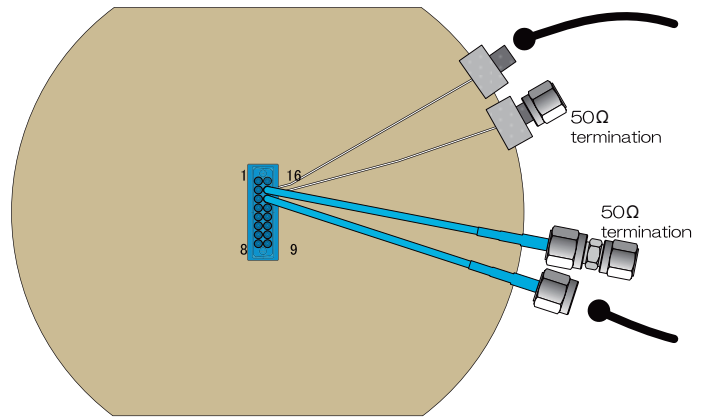

Note) Values within the performance charts are typical values, not guaranteed values.

Features

- Stable characteristic impedance
- Extremely small phase fluctuation due to temperature change
- Excellent mechanical strength
- Supports high frequency
- Small diameter
- Outstanding heat resistance/chemical resistance

Applications

- Semiconductor testing
- Connecting high-frequency device lead wire
- Mobile telecommunications base station
- Antennas
- High-speed differential transmission

Cable Structure

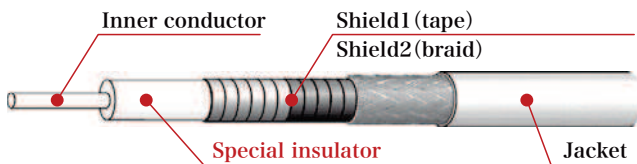

Cable Performance

Characteristic impedance stability

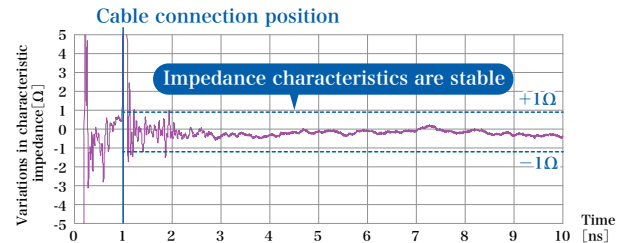

Phase fluctuation due to environmental temperature change

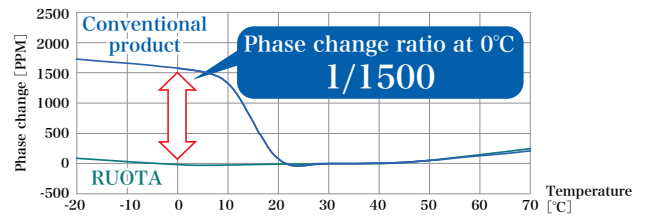

Mechanical strength (bending life)

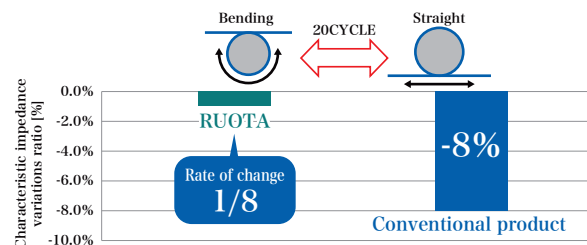

Mechanical strength (minimum bending radius)

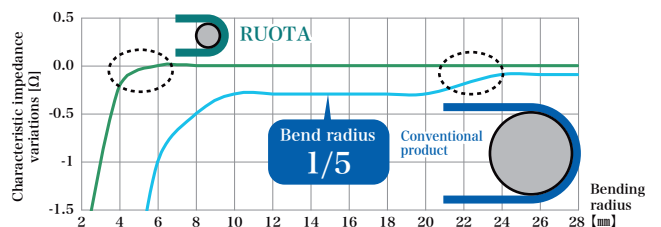

Standard cable size inspection equipment of semiconductors

Conductor composition	Stranded wire
Conductor material	SPC, TCW
AWG size(mm)	26(7/0.16)~32(7/0.08)
Dielectric material	LD PFA
Dielectric Color	Natural hue (tranceruent), Optional color (green)
Characteristic impedance(Ω)	51±1, 50±1
Applications	Application for inspection equipment of semiconductors and PCB
Standard jacket color	gray

Note) Values within the performance charts are typical values, not guaranteed values.

High performance Coaxial Cable & Assembly

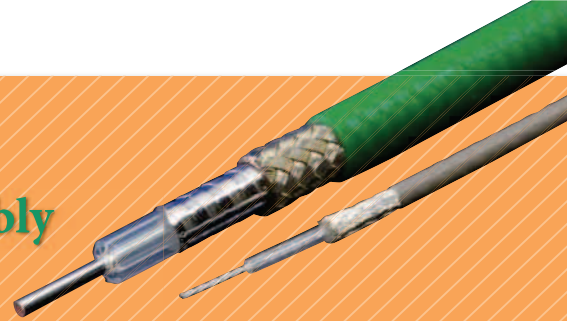

Standard cable size for internal wiring and connecting high-frequency device

Model	TCA322
Conductor composition	Solid wire
Conductor material	SPC
AWG size	0.93
Dielectric material	LD PFA
Dielectric color	Natural color
Characteristic impedance (Ω)	50 ± 1
Standard jacket color	Green
Overall diameter (mm)	3.8 ± 0.1

Cable Assembly

We developed an assembly with SMA both-end plug connector which can be used with RUOTA cable for up to 20GHz microwaveband. It is a high mechanical-strength assembly with limited phase variations from temperature fluctuations. It is suited for use in Internal wiring as well as in connecting high-frequency devices.

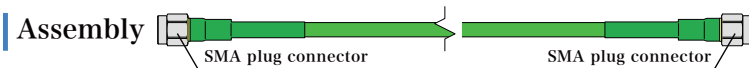

Assy part number / specs

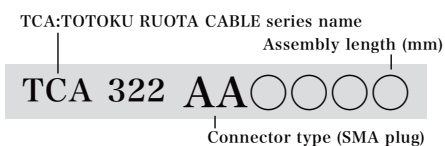

Applications

- Internal wiring use (mobile base station, Antennas)
- Connecting high-frequency device Use

Electrical characteristic (typical)

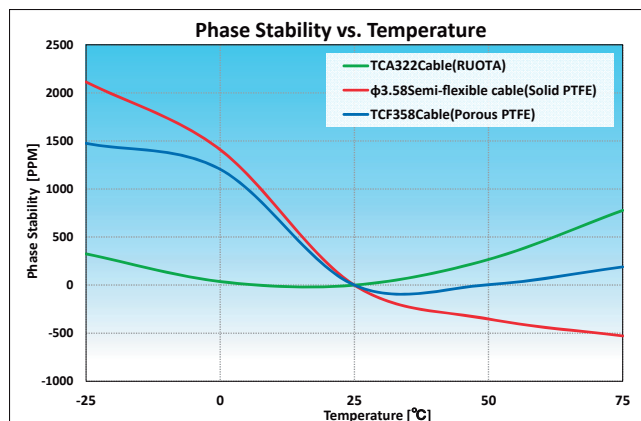
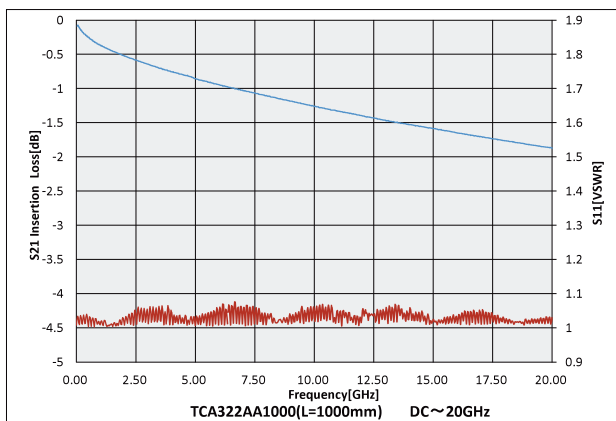

Note) Values within the performance charts are typical values, not guaranteed values.

TOTOKU

TOTOKU INC.

Head Office / 3-8-3 Nishi-Shinbashi, Minato-ku, Tokyo, 105-0003 Japan

Device Sales Section, Sales and Marketing Department, Sales and Marketing Division

TEL: +81-3-5860-2129 FAX: +81-3-5860-2136

West Japan sales office / 4-1-17 Higashinoda-machi, Miyakojima-ku, Osaka, 534-0024 Japan

Sales and Marketing Department, Sales and Marketing Division.

TEL: +81-6-6352-3541 FAX: +81-6-6354-0828

URL: [Japanese site] <https://www.totoku.co.jp/> [English site] <https://www.totoku.com/>



TOTOKU has obtained the following certifications: the ISO 14001, an international standard for Environmental Management Systems, and the ISO 9001, an international standard for Quality Management Systems.

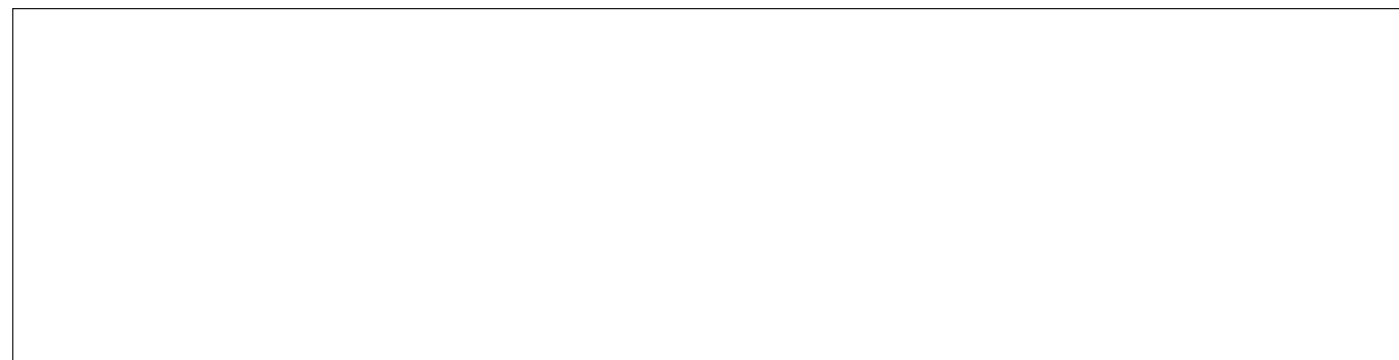

"TOTOKU", "RUOTA" and "Wavemolle" are registered trademarks of TOTOKU INC.

The specifications, standards and/or designs shown in this catalogue are subject to change without notice to improve products.